

# INLINE

Sistema de rodapés em alumínio

**Extrusal**<sup>®</sup>  
Indoor Aluminium

Abril 2011



## INLINE

Rodapés em perfis de alumínio, para espaços domésticos (de 57mm) e espaços públicos (de 100mm) especialmente desenhados para funcionarem em completa harmonia com os aros de porta referidos anteriormente (INSPAN PULL e INSPAN SLIDE) oferecem uma aplicação fácil e rápida e uma resistência funcional de eleição.

O sistema de rodapés INLINE em perfis de alumínio está ainda dotado de um conjunto de cantos (côncavos e convexos) e topos em alumínio que promovem a facilidade de aplicação e a segurança no habitat.

## Componentes/Acessórios



**G.029.001**  
Mola clipar p/ rodapé



**G.027.154**  
Base para rodapé

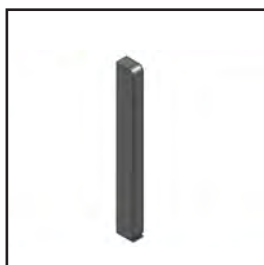

**G.027.157**  
Topo rodapé esq./drt.  
p/ HF014011

**G.027.160**  
Topo rodapé esq./drt.  
p/ HF014012



**G.027.156**  
Canto interior p/ HF014011

**G.027.159**  
Canto interior p/ HF014012

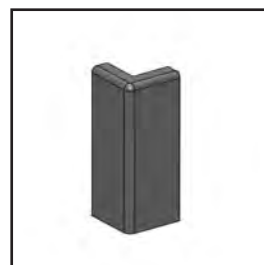

**G.027.155**  
Canto exterior p/ HF014011

**G.027.158**  
Canto exterior p/ HF014012



**G.027.157**  
Topo rodapé esq./drt. p/ HF014011

**G.027.160**  
Topo rodapé esq./drt. p/ HF014012

**G.027.156**  
Canto interior p/ HF014011

**G.027.159**  
Canto interior p/ HF014012

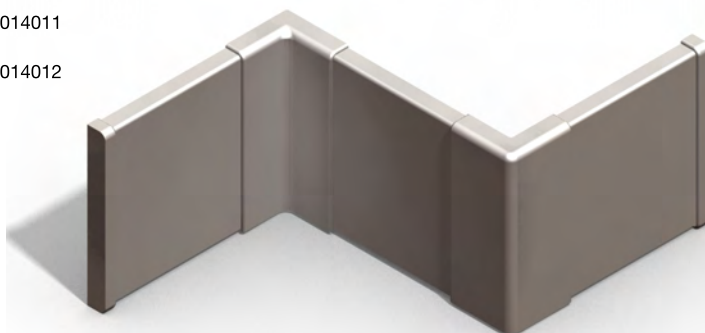

**G.027.155**  
Canto exterior p/ HF014011

**G.027.158**  
Canto exterior p/ HF014012

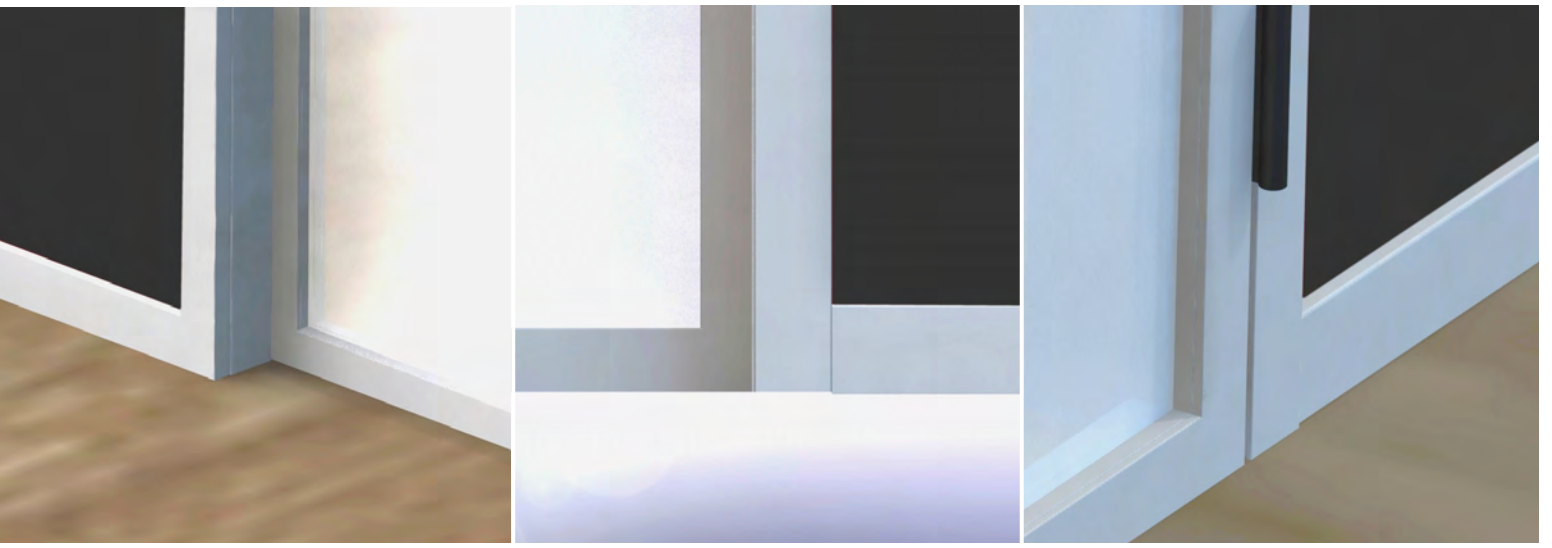

## INLINE (Rodapé)

**HF014010**  
3000mm/4000mm\*

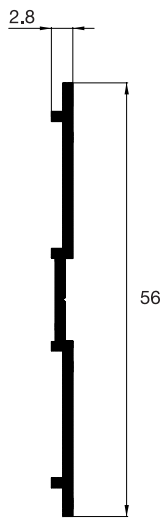

Utilizar c/ G029001  
\* Opcional: G027154

**HF014011**  
3000mm/4000mm/6000mm

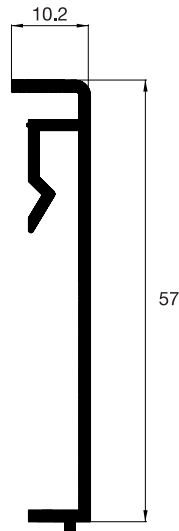

HF0140113000 - 3000mm  
HF0140114000 - 4000mm

**HF014012**  
3000mm/4000mm/6000mm

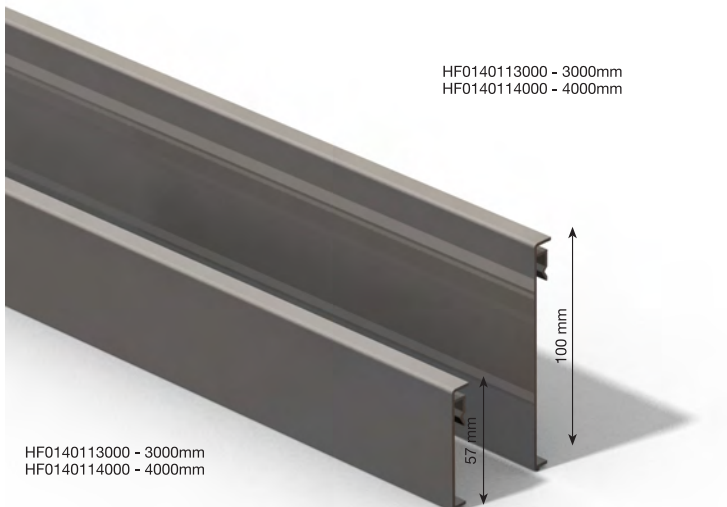
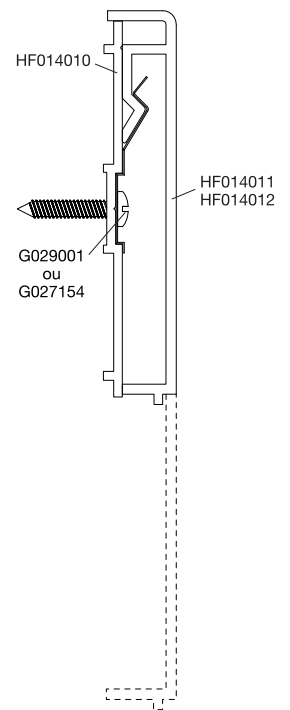
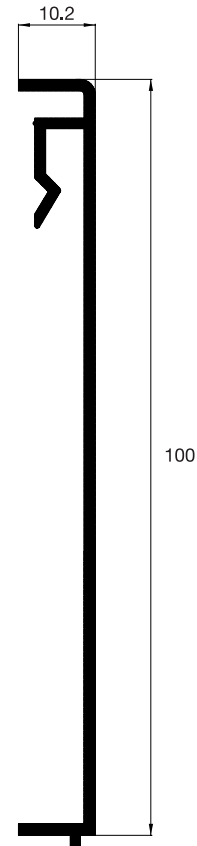

HF0140113000 - 3000mm  
HF0140114000 - 4000mm

**etrusal**<sup>®</sup>  
Indoor Aluminium



**Opexil**  
exportação e importação, Lda.

Rua da valada, 44 3860-125 Avanca-Estarreja

Telf.: +351 234 884 494

Fax: +351 234 880 122

[indoor@opexil.pt](mailto:indoor@opexil.pt)