



INSPAN *PULL*

Sistema de aros ajustáveis em alumínio para portas de batente interiores



Extrusal[®]
Indoor Aluminium



Junho 2016

grupo extrusal

Sistema de aros ajustáveis em alumínio para portas de batente interiores.

Resistência, adaptabilidade, excelência do alumínio e facilidade de montagem são os atributos deste novo sistema de aros em alumínio para portas de interiores.

Resistência, por isso o sistema inclui rodapés de 75mm para espaços domésticos e rodapés de 100mm para espaços públicos.

Adaptabilidade, pois o sistema oferece a possibilidade de montagem em paredes que podem ir de 85mm a 265mm de espessura.

Excelência do alumínio, para concretizar o seu sonho de ver o alumínio no seu habitat.

Facilidade de montagem, pois foi uma premissa essencial no projecto desenvolvimento deste sistema de aros em alumínio para portas de interior.

Limpeza simples é um atributo relevante neste produto em alumínio que ajuda à higienização da instalação (usar produtos de limpeza neutros).

Não deixamos de apresentar neste programa, como opção, as seguintes soluções em alumínio para as portas:

- F014030 Um perfil de alumínio ligeiro de emolduramento e protecção à porta que oferece cerca de 35mm de enchimento e uma vista de apenas 10mm.
- A017005 Um aro móvel do sistema A017 EXTRUSAL que oferece um enchimento de 30mm e uma vista de 58mm.
- A017005 + A017012 A mesma solução anterior mas apenas com um enchimento de 8mm.

Componentes/Acessórios



G.029.001
Mola clipar p/ rodapé



G.027.154
Base para rodapé



G.004.428
Dobradiça para porta de vai-vém



G.024.001
Dobradiça para porta de batente

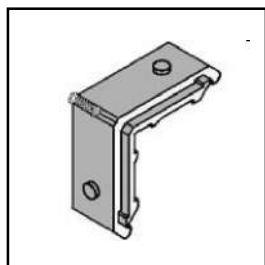

G.004.215
Esquadro aro base



G.027.151
Esquadro aro alinhamento

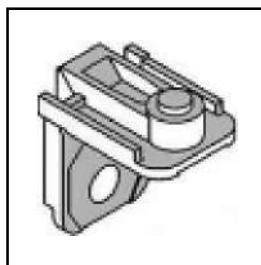

G.004.484
Esquadro Aro

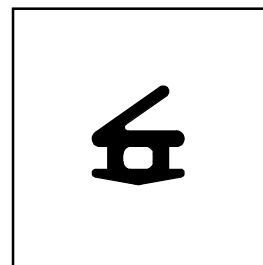

G.001.108
Vedante batente aro fixo/movel

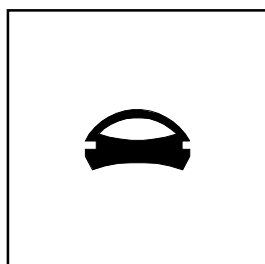

G.027.153
Vedante batente aro fixo

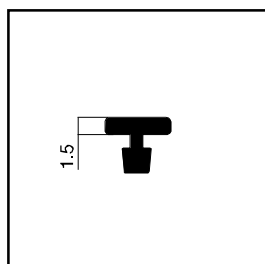

G.027.152
Vedante ajuste



INLINE (Rodapé)

HF014010
3000mm/4000mm*

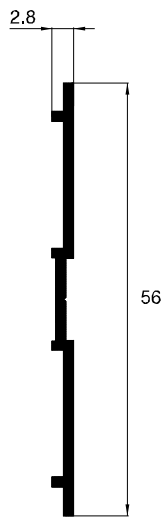

Utilizar c/ G029001
* Opcional: G027154

HF014011
3000mm/4000mm/6000mm

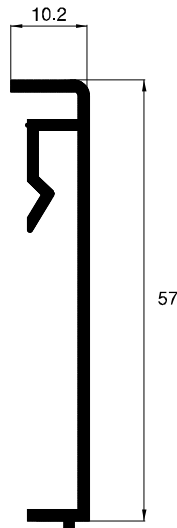

G.027.156
Canto interior p/ HF014011
G.027.159
Canto interior p/ HF014012

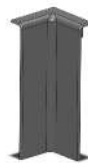

HF014012
3000mm/4000mm/6000mm

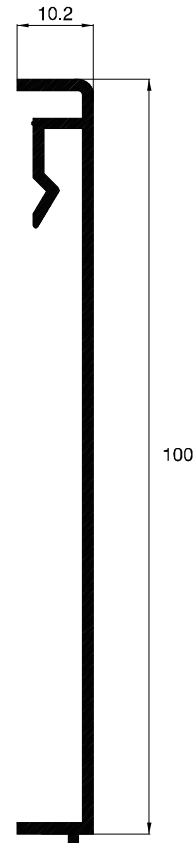

G.027.157
Topo rodapé esq./drt. p/ HF014011
G.027.160
Topo rodapé esq./drt. p/ HF014012

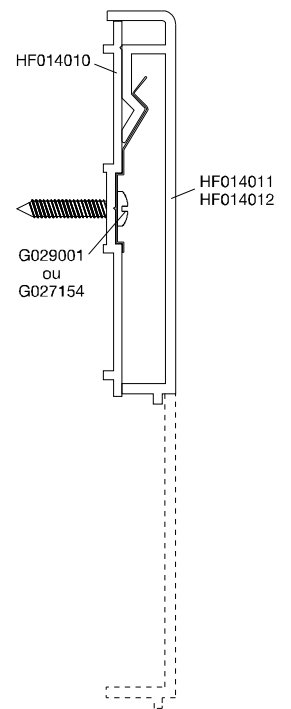
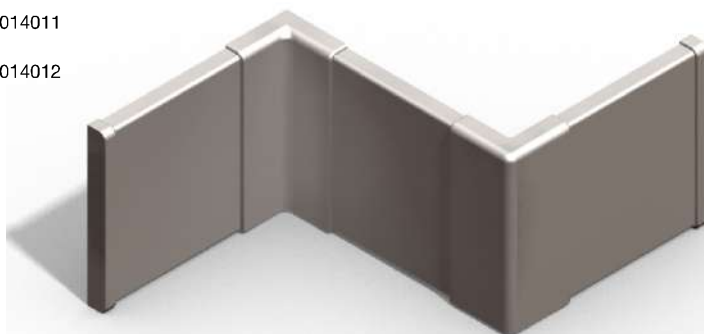

G.027.155
Canto exterior p/ HF014011
G.027.158
Canto exterior p/ HF014012

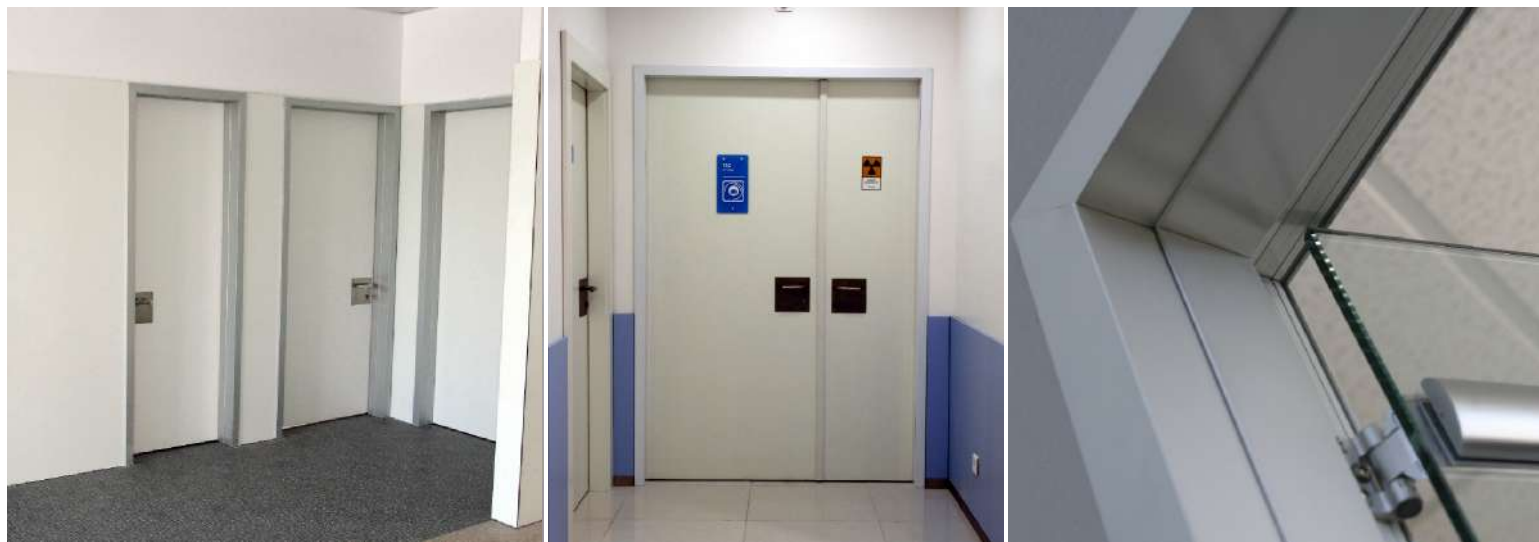

Perfil base de aro para porta de Batente

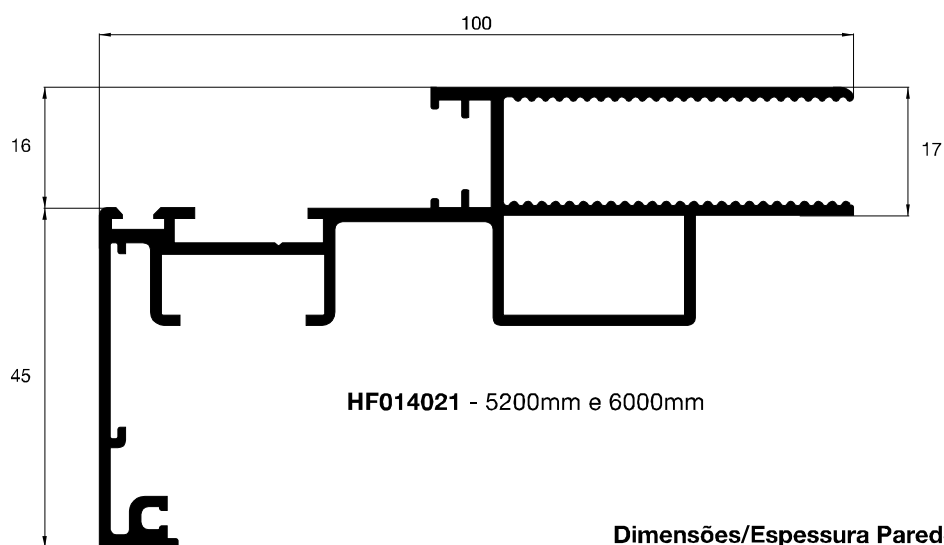

Dimensões/Espessura Parede

HF014021 + HF014022 - min. 81mm/max. 103mm
 HF014021 + HF014023 - min. 111mm/max. 139mm
 HF014021 + HF014024 - min. 140mm/max. 169mm
 HF014021 + HF014025 - min. 176mm/max. 203mm
 HF014021 + HF014026 - min. 223mm/max. 253mm

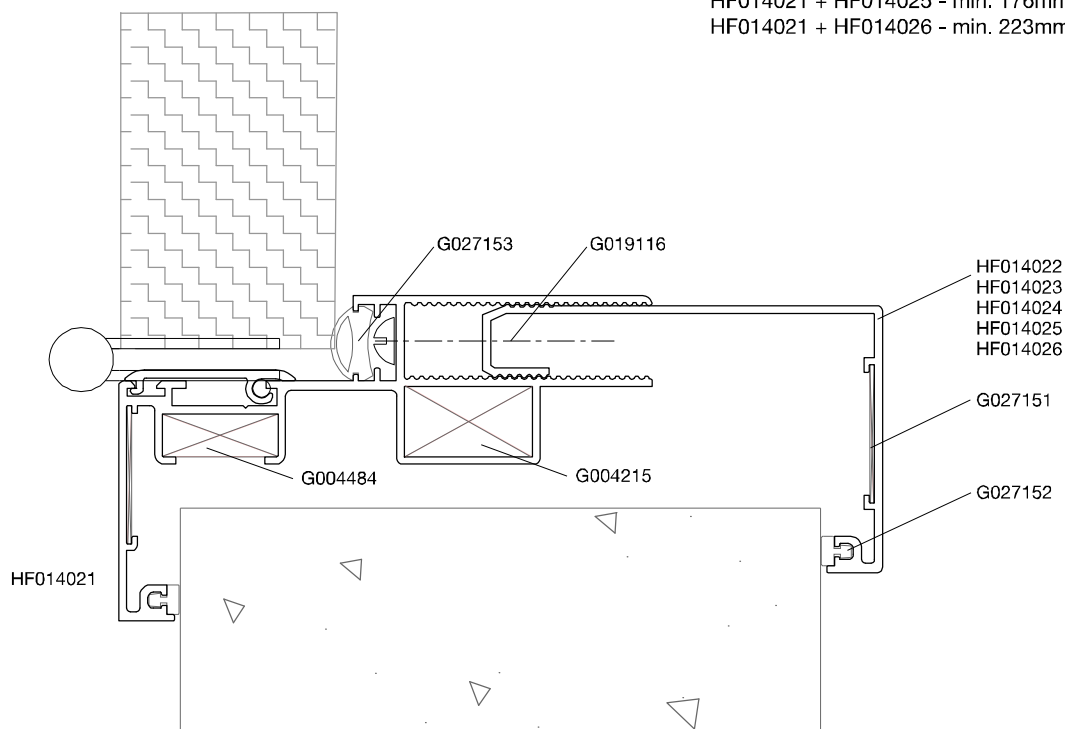



Perfil base de aro para porta de Vai-Vém

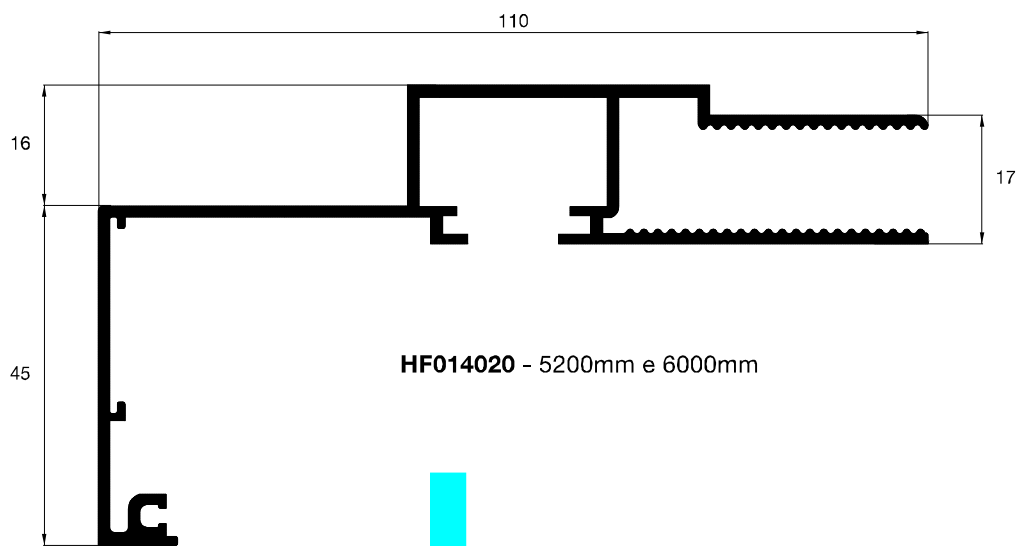

Dimensões/Espessura Parede

HF014020 + HF014022 - min. 95mm/max. 117mm
 HF014020 + HF014023 - min. 124mm/max. 151mm
 HF014020 + HF014024 - min. 154mm/max. 181mm
 HF014020 + HF014025 - min. 190mm/max. 216mm
 HF014020 + HF014026 - min. 240mm/max. 268mm

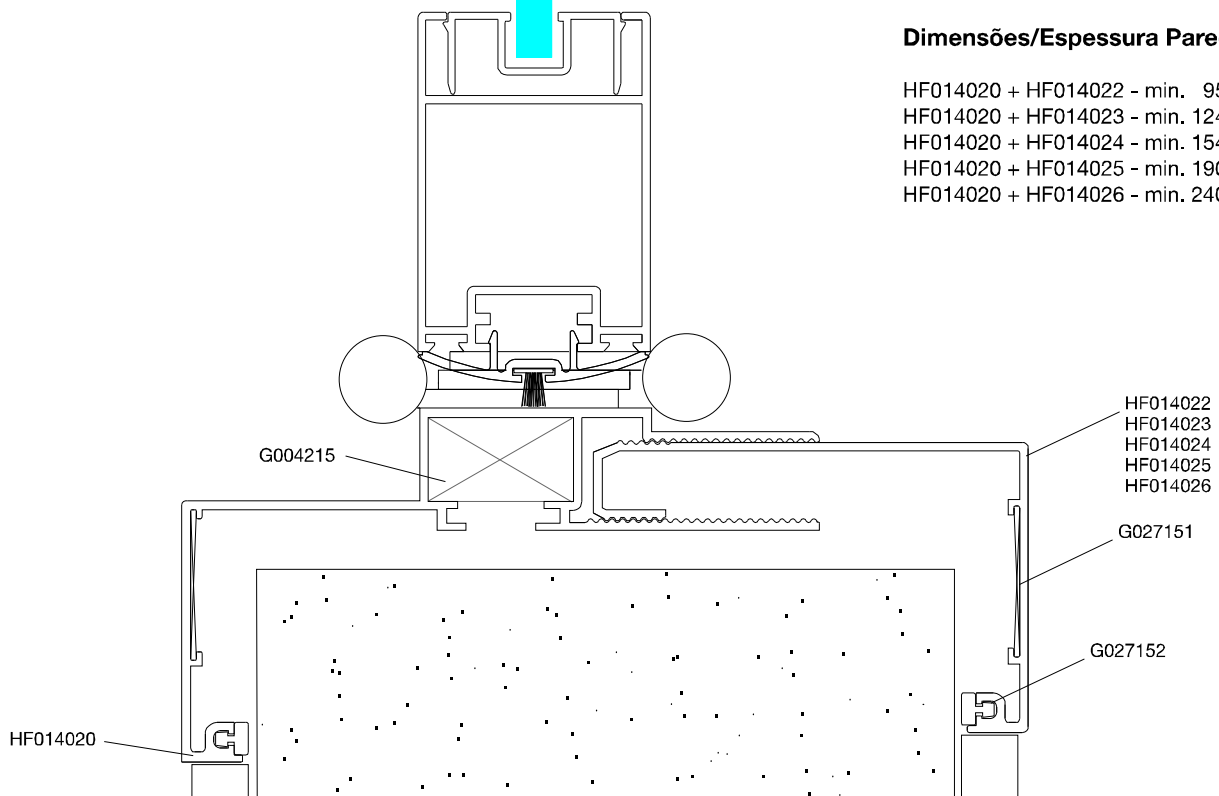

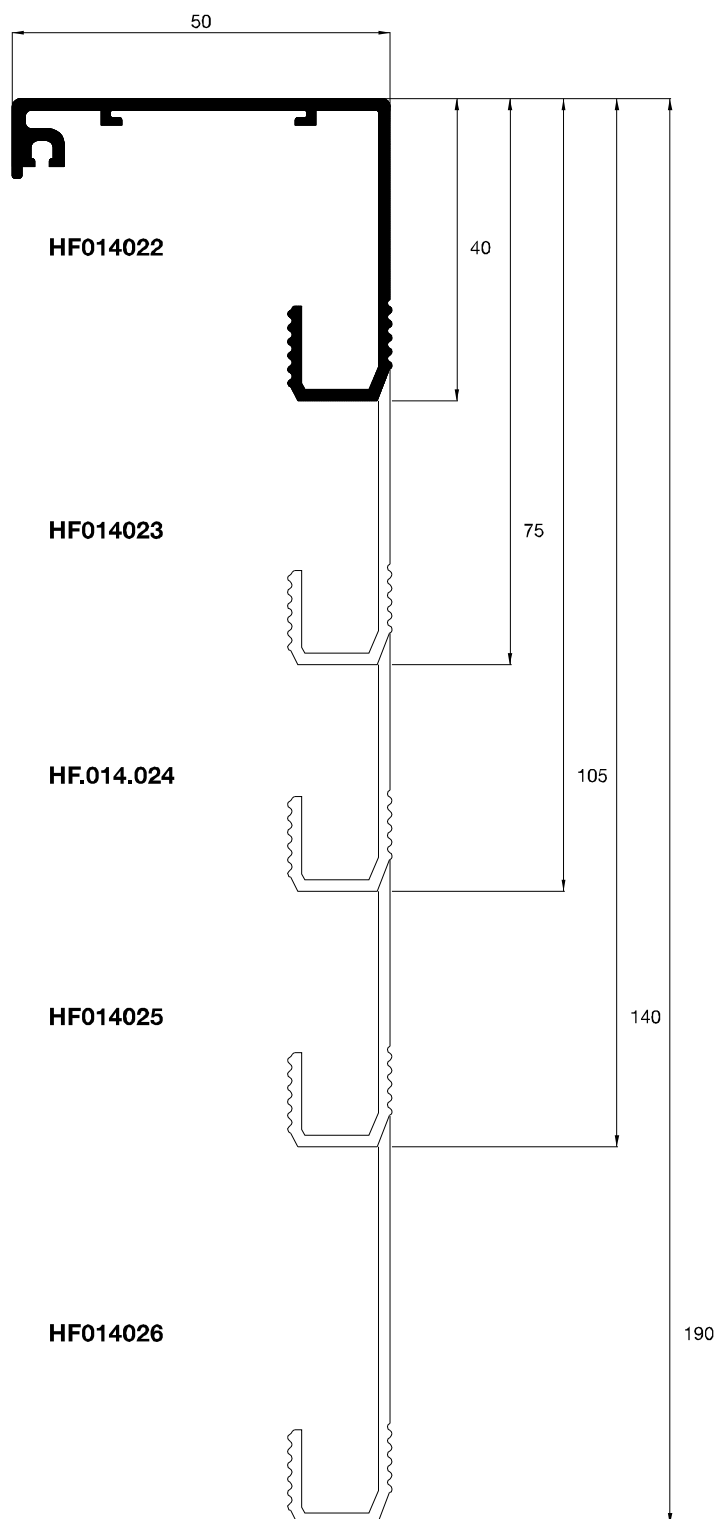

Perfis fornecidos a
5200mm e 6000mm

HF014030

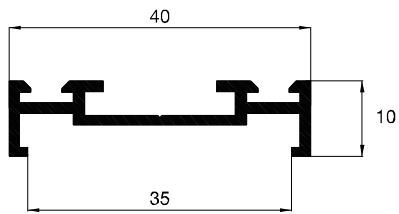

HF014030

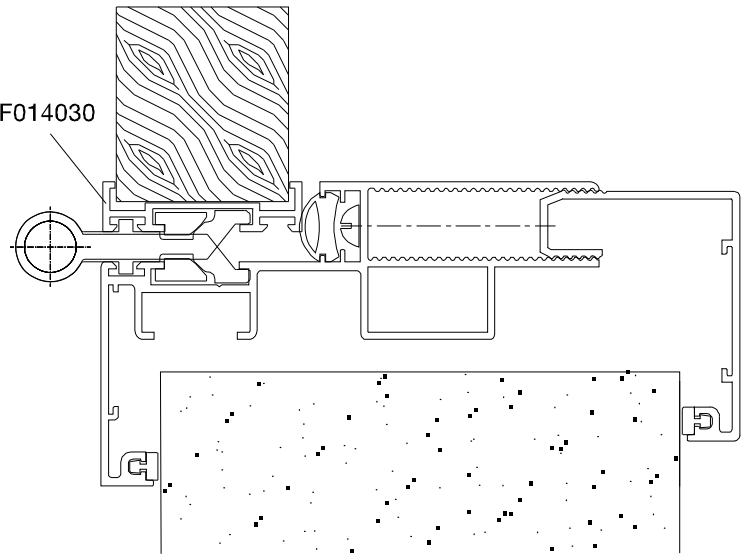

HF014031

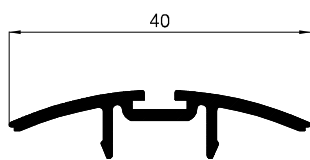

HA017012

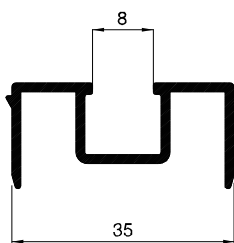

HA017005

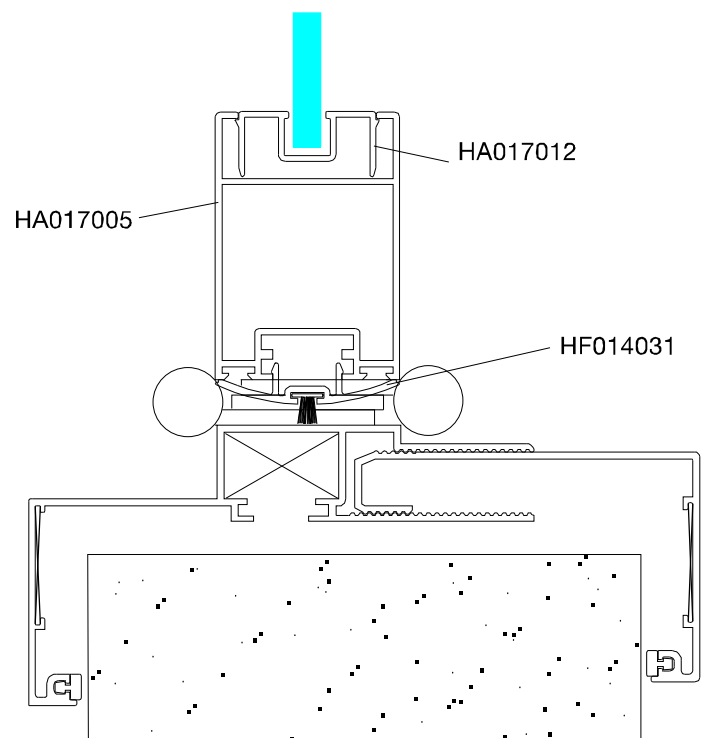

HA017005

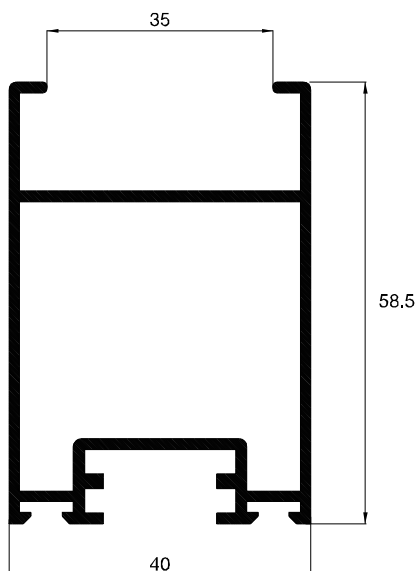

Perfil Capot

HF014032
6000mm

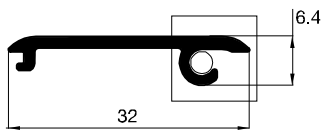

Oringue

G001113

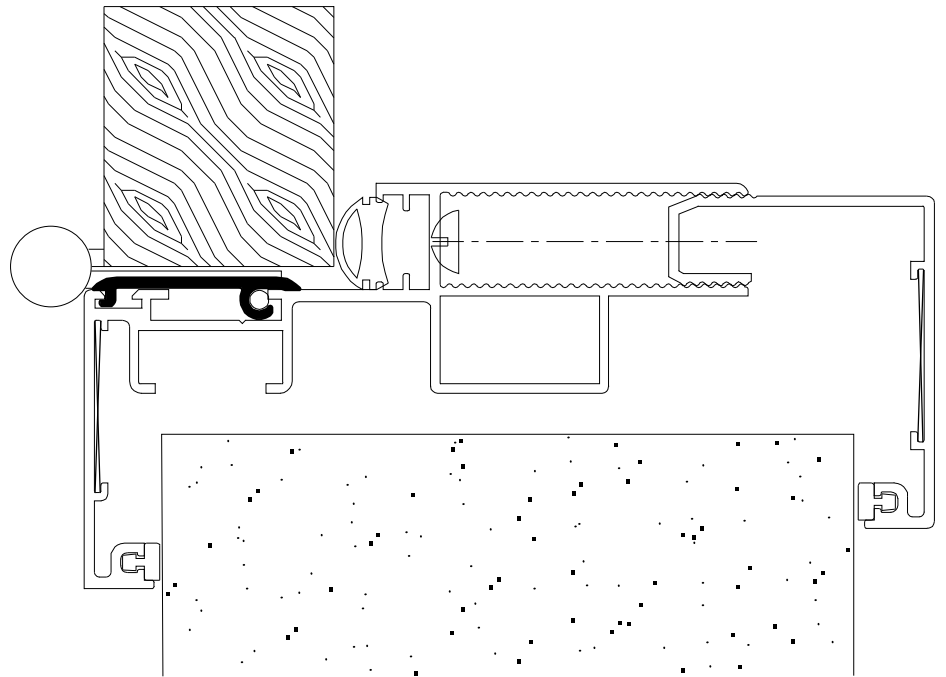

HA040023
3000mm

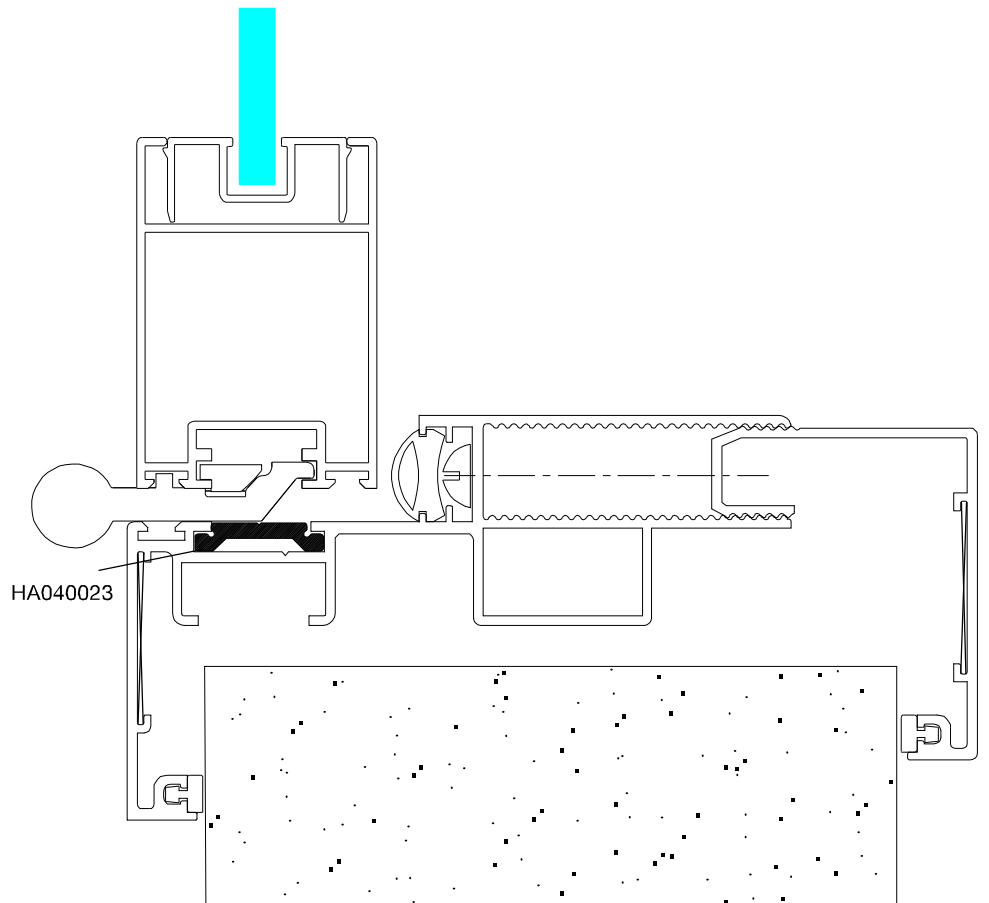
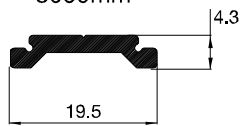

Perfil extensão de espessura de parede

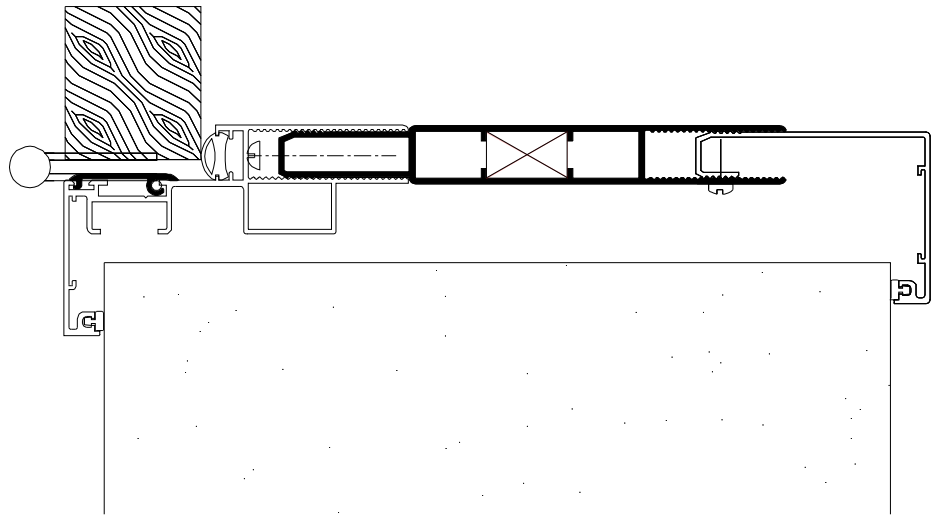
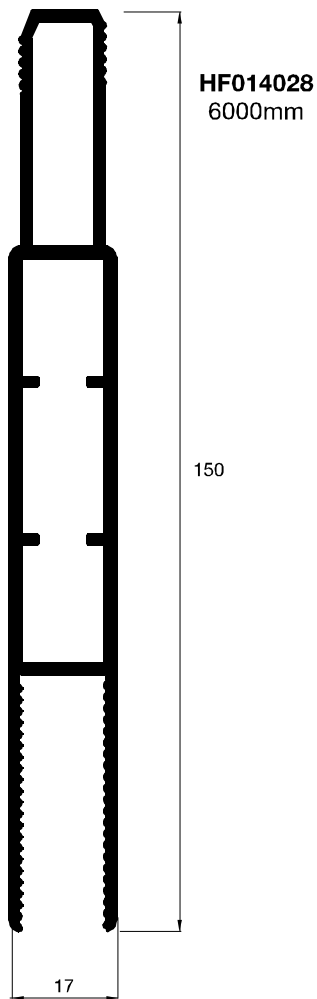

Dimensões/Espessura Parede

HF014021 + HF014022 + HF014028 - min. 191mm/max. 213mm
 HF014021 + HF014023 + HF014028 - min. 221mm/max. 249mm
 HF014021 + HF014024 + HF014028 - min. 250mm/max. 279mm
 HF014021 + HF014025 + HF014028 - min. 286mm/max. 313mm
 HF014021 + HF014026 + HF014028 - min. 333mm/max. 363mm

HF014020 + HF014022 + HF014028 - min. 205mm/max. 227mm
 HF014020 + HF014023 + HF014028 - min. 234mm/max. 261mm
 HF014020 + HF014024 + HF014028 - min. 264mm/max. 291mm
 HF014020 + HF014025 + HF014028 - min. 300mm/max. 326mm
 HF014020 + HF014026 + HF014028 - min. 350mm/max. 378mm

Perfil extensão de profundidade de recepção da parede

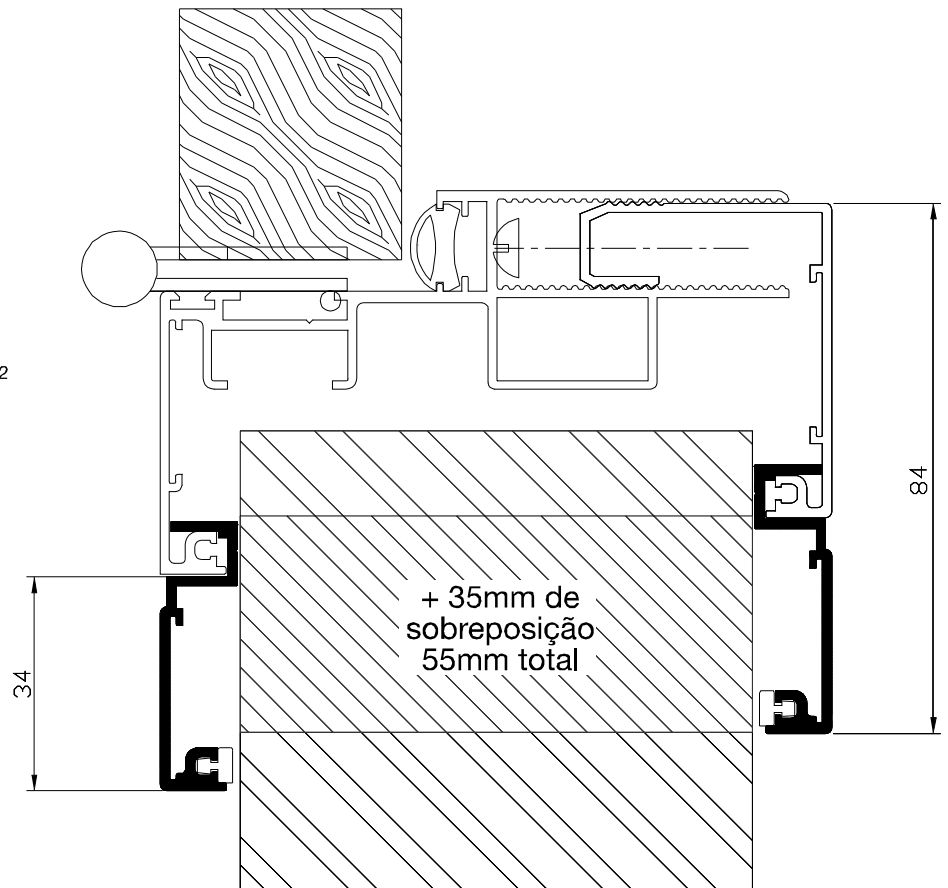
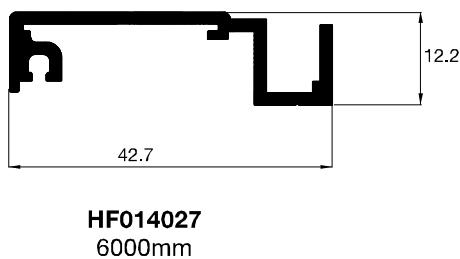



INSPAN PULL - Linha ALUMINIUM TOUCH

Dobradiças



G.027.350
Dobradiça mista 75x75
inox Direita (3) 30kg



G.027.351
Dobradiça mista 75x75
inox Esquerda (3) 30kg



G.027.352
Dobradiça recta 75x75
inox (3) 30kg



G.027.353
Dobradiça recta 101x76
inox (3) 80kg

Puxadores



G.027.400
Puxador Alumínio



G.027.401
Puxador Alumínio



G.027.402
Puxador Alumínio



G.027.403
Puxador Alumínio



G.027.404
Puxador Alumínio



G.027.405
Puxador Alumínio

Fechaduras



G.027.551
Fechadura CH Z Trinco
Nylon T CM TB60



G.027.552
Fechadura Passagem
Trinco Nylon T CM TB60



G.027.553
Fechadura EU Trinco
Nylon T CM TB60



Chapa Testa



G.027.550
Chapa Testa
Alumínio

INSPAN PULL - Linha PERFECT INOX

Dobradiças



G.027.350
Dobradiça mista 75x75
inox Direita (3) 30kg



G.027.351
Dobradiça mista 75x75
inox Esquerda (3) 30kg



G.027.352
Dobradiça recta 75x75
inox (3) 30kg



G.027.353
Dobradiça recta 101x76
inox (3) 80kg

Puxadores



G.027.410
Puxador Inox



G.027.411
Puxador Inox



G.027.412
Puxador Inox



G.027.413
Puxador Inox



G.027.414
Puxador Inox



G.027.415
Puxador Inox

Fechaduras



G.027.501
Fechadura 1 ponto
Trico inox

Chapa Testa



G.027.502
Chapa Testa inox

INSPAN PUL - Linha GLASS

Dobradiças



G.027.200
Dobradiça Gliss

Puxadores



G.027.201
Puxador Forma

Fechaduras



G.027.202
Trinco/Fechadura
Forma

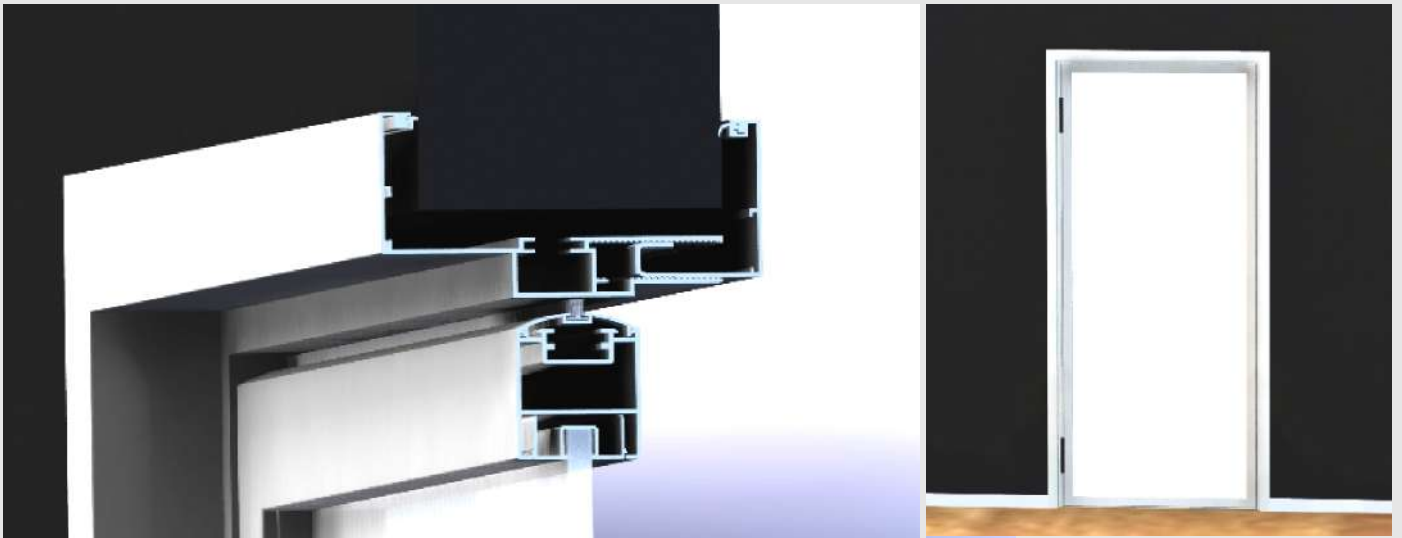

Extrusal[®]
Indoor Aluminium



Opexil
exportação e importação, Lda.

Rua da valada, 44 3860-125 Avanca-Estarreja

Telf.: +351 234 884 494

Fax: +351 234 880 122

indoor@opexil.pt