

SISTEMAS ABRIR

FERRAGEM OCULTA 120 KG - 2024.01.145

INFORMAÇÃO TÉCNICA

etrusal[®]

Alumínio com perfil humano.

**FERRAGEM OCULTA 120 KG
APRESENTAÇÃO**

A.175FE | A.175FO | A.175 | A.165 | A.155 | A.040

Sistema de ferragem oculta para 120 kg

Permite a construção de tipologias de uma folha batente e oscilobatente e duas folhas de abrir e oscilobatente mais batente.

ÍNDICE

ACESSÓRIOS	04
ESPESSURA VIDRO CREMONES	05
UMA FOLHA BATENTE	06 - 07
UMA FOLHA OSILOBATENTE	08 - 09
DUAS FOLHAS BATENTE	10 - 11
OSILOBATENTE MAIS BATENTE	12 - 13

FERRAGEM OCULTA 120 KG ACESSÓRIOS NOVOS

A.175FE | A.175FO | A.175 | A.165 | A.155 | A.040

NOVO

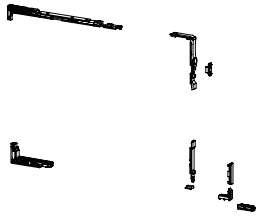

G.053.020
KIT OB Oculto 120 kg
515 - 655mm esq.

NOVO

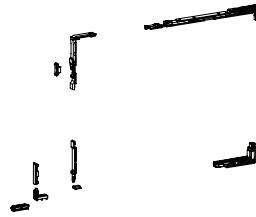

G.053.021
KIT OB Oculto 120 kg
515 - 655mm dir.

NOVO

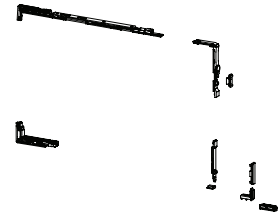

G.053.022
KIT OB Oculto 120 kg
655 - 1300mm esq.

NOVO

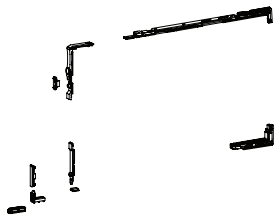

G.053.023
KIT OB Oculto 120 kg
655 - 1300mm dir.

NOVO

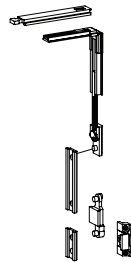

G.053.024
Ponto de Fecho
(Adicional vertical)

NOVO

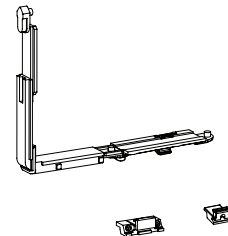

G.053.025
Ponto de Fecho
(Adicional horizontal)

NOVO

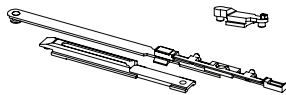

G.053.026
Compasso Suplementar
(L>950mm)

NOVO



G.053.027
Dobradiça Oculta 120 kg
(esquerda)

NOVO



G.053.028
Dobradiça Oculta 120 kg
(direita)

NOVO

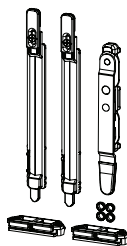

G.053.029
KIT Fecho Bidirecional

FERRAGEM OCULTA 120 KG ESPESSURA VIDRO I CREMONES

A.175FE | A.175FO | A.175 | A.165 | A.155 | A.040

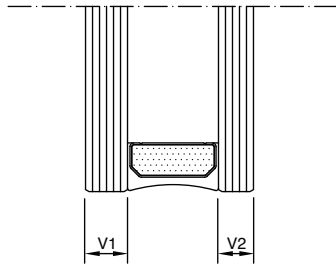

Cálculo

Espessura Máxima Vidro

$$E = V1 + V2$$

2600	36	30	26	22	20	18	16	14	14
2500	38	32	26	24	20	18	16	16	14
2400	40	32	28	24	22	20	18	16	14
2300	40	34	28	26	22	20	18	16	16
2200	40	36	30	26	24	20	18	18	16
2100	40	38	32	28	24	22	20	18	16
2000	40	40	34	30	26	24	20	20	18
1900	40	40	36	30	28	24	22	20	18
1800	40	40	38	32	28	26	24	22	20
1700	40	40	40	34	30	28	24	22	20
1600	40	40	40	36	32	30	26	24	22
1500	40	40	40	40	34	32	28	26	24
1400	40	40	40	40	38	34	30	28	26
1300	40	40	40	40	40	36	32	30	28
1200	40	40	40	40	40	40	36	32	30
1100	40	40	40	40	40	40	38	36	32
1000	40	40	40	40	40	40	40	40	
900	40	40	40	40	40	40	40		
800	40	40	40	40	40	40			
700	40	40	40	40	40				
600	40	40	40	40					
500	40	40	40						
H / L	500	600	700	800	900	1000	1100	1200	1300

URBAN
G.052.001

Linha Cremones

AXIS
G.052.101

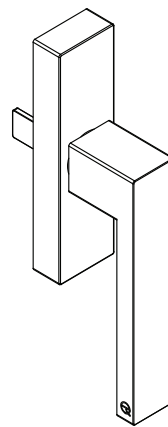
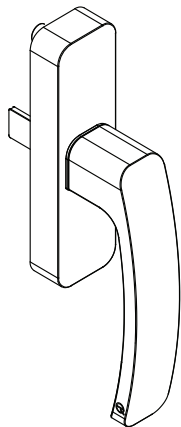

FERRAGEM OCULTA 120 KG UMA FOLHA BATENTE

A.175FE | A.175FO | A.175 | A.165 | A.155 | A.040

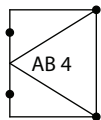
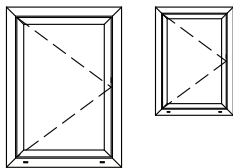

515 < largura < 1300
400 < altura < 1200

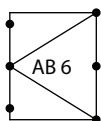

515 < largura < 1300
1201 < altura < 2000

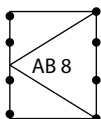

515 < largura < 1300
2001 < altura < 2600

	referência urban	referência axis	designação	AB 4	AB 6	AB 8
Ferragem Base	G.052.001	G.052.101	Cremone 1G			
	G.052.002	G.052.102	Cremone 1G c/ chave	1	1	1
	G.052.003	G.052.103	Cremone 1G segurança c/ punho			
		G.052.060	Transmissão cremone 1G	1	1	1
		G.052.067	Suporte folha	1	1	1
		G.052.072	Ponto de fecho folha	2	3	4
		G.052.073	Ponto de fecho aro	2	3	4
Ferragem Opcional	G.052.005	G.052.105	Cremone 2G			
	G.052.006	G.052.106	Cremone 2G c/ chave	1	1	1
	G.052.008	G.052.108	Cremone 2G segurança c/ punho			
		G.052.061	Transmissão cremone 2G	1	1	1
		G.052.067	Suporte folha	1	1	1
		G.052.072	Ponto de fecho folha	-	1	2
		G.052.073	Ponto de fecho aro	-	1	2
		G.052.074	Fecho ponteira folha	2	2	2
Dobradiças Ocultas	G.053.027		Dobradiça Oculta 120 kg esq.	1	1	1
	G.053.028		Dobradiça Oculta 120 jg dir.	1	1	1
	G.052.068		Limitador de flecha	-	1	2

FERRAGEM OCULTA 120 KG UMA FOLHA BATENTE

A.175FE | A.175FO | A.175 | A.165 | A.155 | A.040

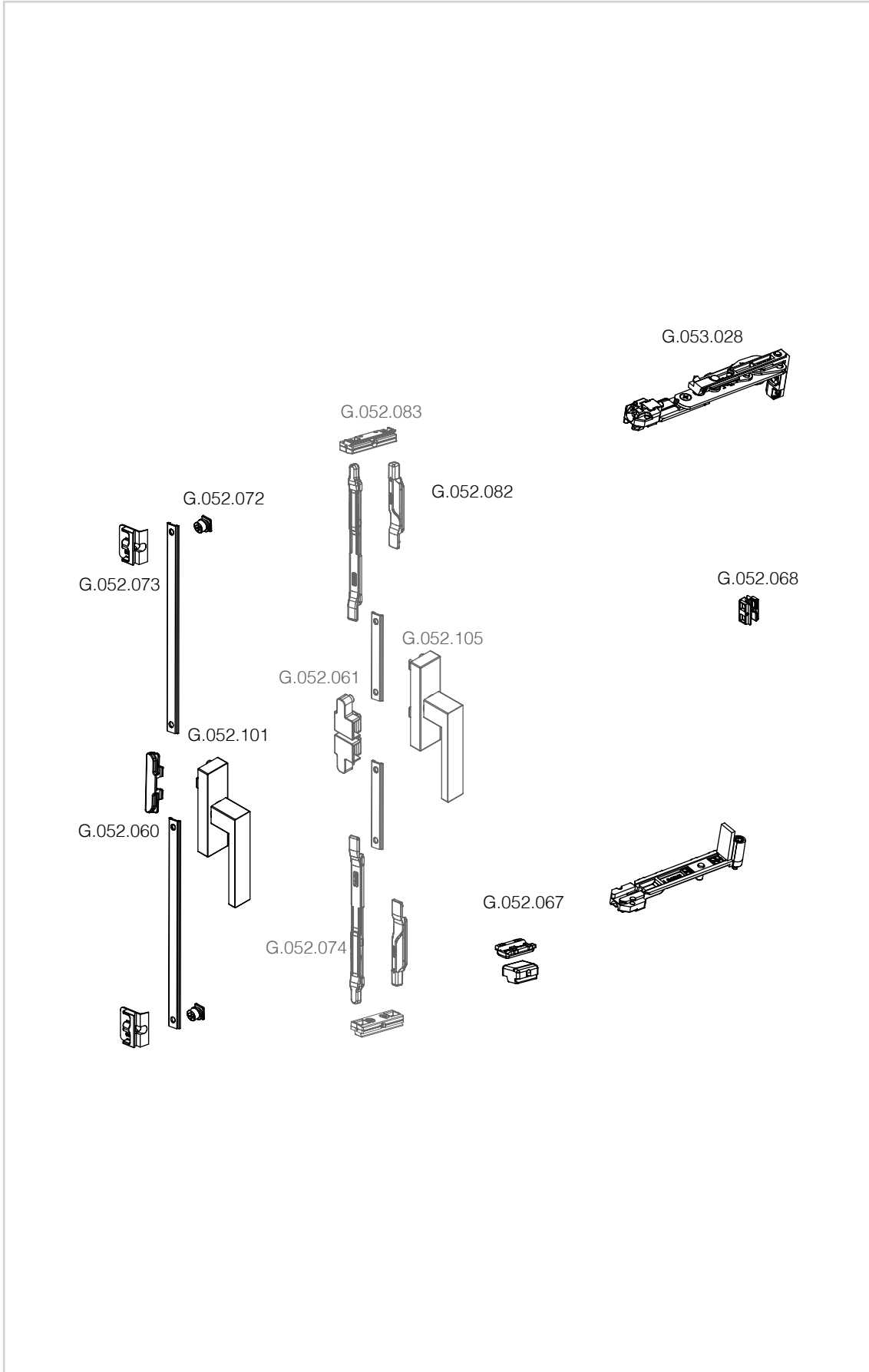

FERRAGEM OCULTA 120 KG UMA FOLHA OSCIOBATENTE

A.175FE | A.175FO | A.175 | A.165 | A.155 | A.040

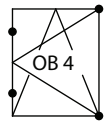
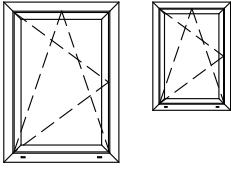

515 < largura < 655
500 < altura < 1400

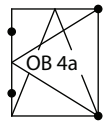

656 < largura < 950
500 < altura < 1400

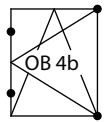

950 < largura < 1300
500 < altura < 1400

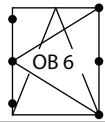

515 < largura < 655
1401 < altura < 2000

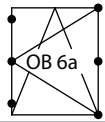

656 < largura < 950
1401 < altura < 2000

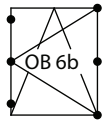

950 < largura < 1300
1401 < altura < 2000

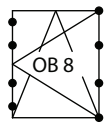

515 < largura < 655
2001 < altura < 2600

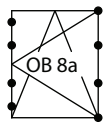

656 < largura < 950
2001 < altura < 2600

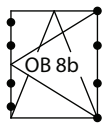

950 < largura < 1300
2001 < altura < 2600

	referência urban	referência axis	designação	OB 4	OB 4a	OB 4b	OB 6	OB 6a	OB 6b	OB 8	OB 8a	OB 8b
Ferragem Base	G.052.001	G.052.101	Cremona 1G	1	1	1	1	1	1	1	1	1
	G.053.020		Kit OB 515 - 655mm esq.	1	-	-	1	-	-	1	-	-
	G.053.021		Kit OB 515 - 655mm dir.	1	-	-	1	-	-	1	-	-
	G.053.022		Kit OB 655 - 1300mm esq.	-	1	1	-	1	1	-	1	1
	G.053.023		Kit OB 655 - 1300mm dir.	-	1	1	-	1	1	-	1	1
Ferragem Opcional	G.052.060		Transmissão cremone 1G	1	1	1	1	1	1	1	1	1
	G.052.072		Ponto de fecho folha	-	-	-	1	1	1	2	2	2
	G.052.073		Ponto de fecho aro	-	-	-	1	1	1	2	2	2
	G.053.024		Ponto fecho ad. vertical	-	-	-	1	1	1	1	1	1
	G.053.025		Ponto fecho ad. horizontal	-	-	1	-	-	1	-	-	1
	G.053.026		Compasso sup. L>950mm	-	-	1	-	-	1	-	-	1

Para mais informações consultar **Anexo A.04**

FERRAGEM OCULTA 120 KG UMA FOLHA OSCIOBATENTE

A.175FE | A.175FO | A.175 | A.165 | A.155 | A.040

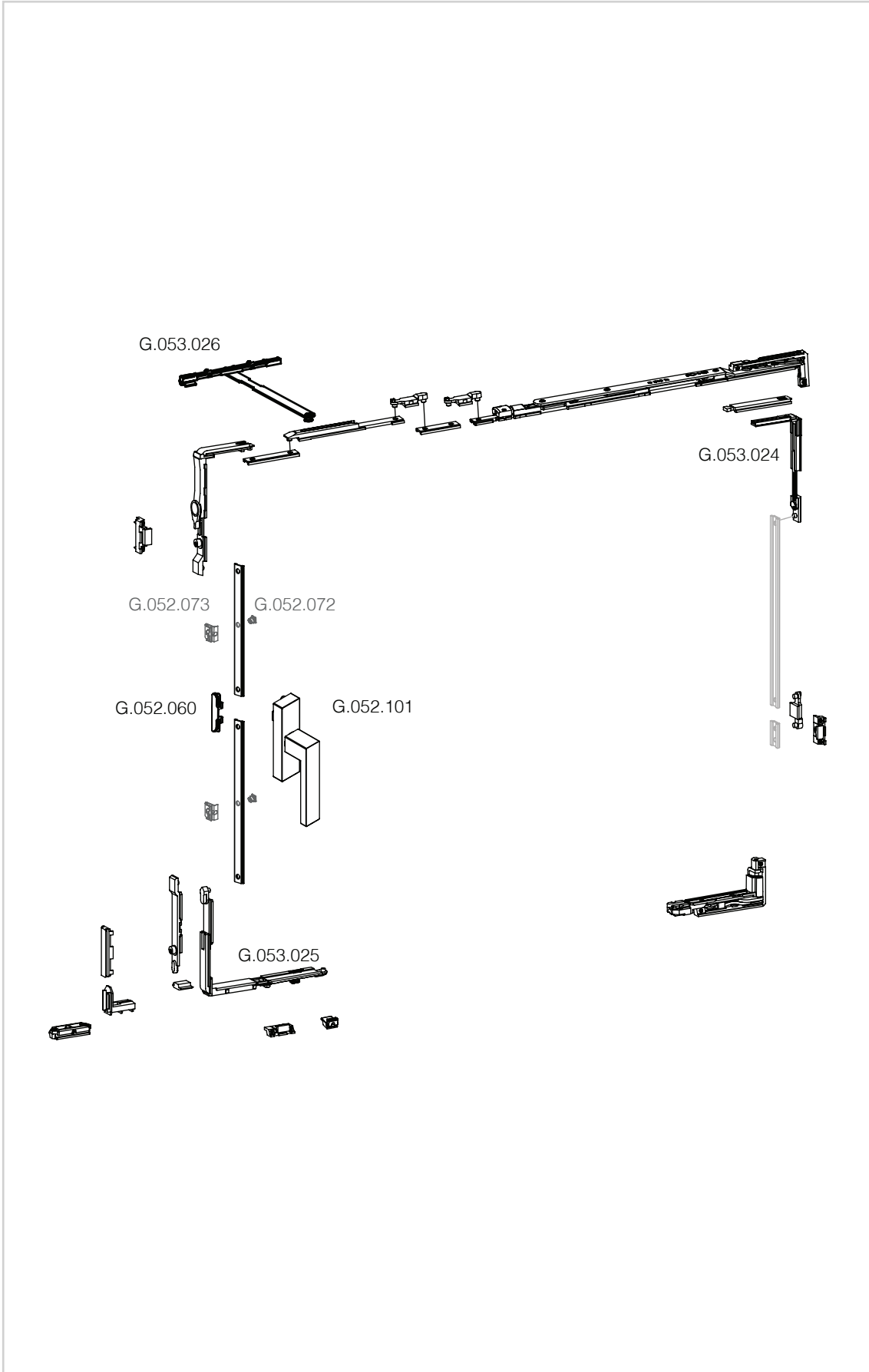

FERRAGEM OCULTA 120 KG DUAS FOLHAS BATENTE

A.175FE | A.175FO | A.175 | A.165 | A.155 | A.040

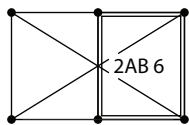
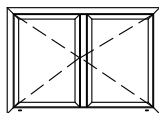
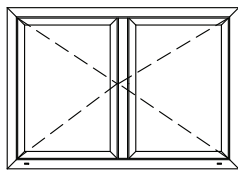

515 < largura < 1300

400 < altura < 1400

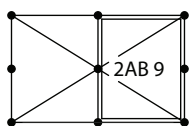

515 < largura < 1300

1401 < altura < 2000

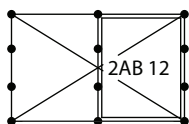

515 < largura < 1300

2001 < altura < 2600

		referência	designação	2 AB 6	2 AB 9	2 AB 12	
		urban	axis				
Ferragem Folha Ativa		G.052.005	G.052.105	Cremone 2G			
		G.052.006	G.052.106	Cremone 2G c/ chave	1	1	1
		G.052.008	G.052.108	Cremone 2G segurança c/ punho			
		G.052.061		Transmissão cremone 2G	1	1	1
		G.052.067		Suporte folha	1	1	1
		G.052.072		Ponto de fecho folha	-	1	2
		G.052.073		Ponto de fecho aro	-	1	2
Ferragem Folha Passiva		G.052.074		Fecho ponteira folha	2	2	2
		G.052.082		Fecho ponteira nylon folha	2	2	2
		G.052.075		Engate duplo aro	2	2	2
		G.052.070	ou ou	Fecho de 2ª c/ alavanca	2	2	2
		G.052.071		Fecho bidirecional	1	1	1
		G.052.081		Fecho nylon 2ª folha	2	2	2
		G.052.067		Suporte folha	1	1	1
	G.052.074		Fecho ponteira folha	2	2	2	
	G.052.082		Fecho ponteira nylon folha	1	1	1	
Dobradiças Ocultas		G.053.027		Dobradiça Oculta 120 kg esq.	2	2	2
		G.053.028		Dobradiça Oculta 120 kg dir.	2	2	2
		G.052.068		Limitador de flecha	-	2	4

FERRAGEM OCULTA 120 KG DUAS FOLHAS BATENTE

A.175FE | A.175FO | A.175 | A.165 | A.155 | A.040

Folha Ativa

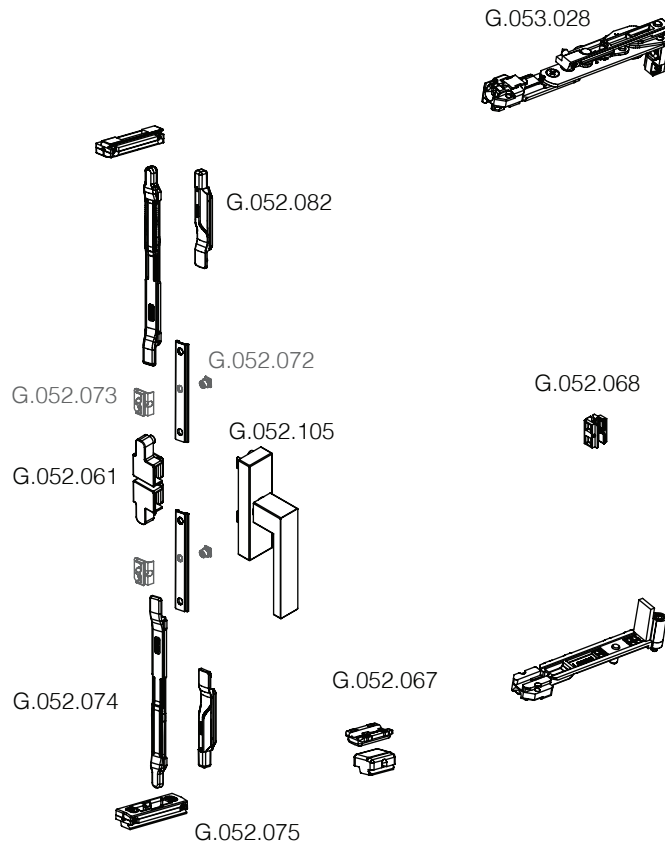

Folha Passiva

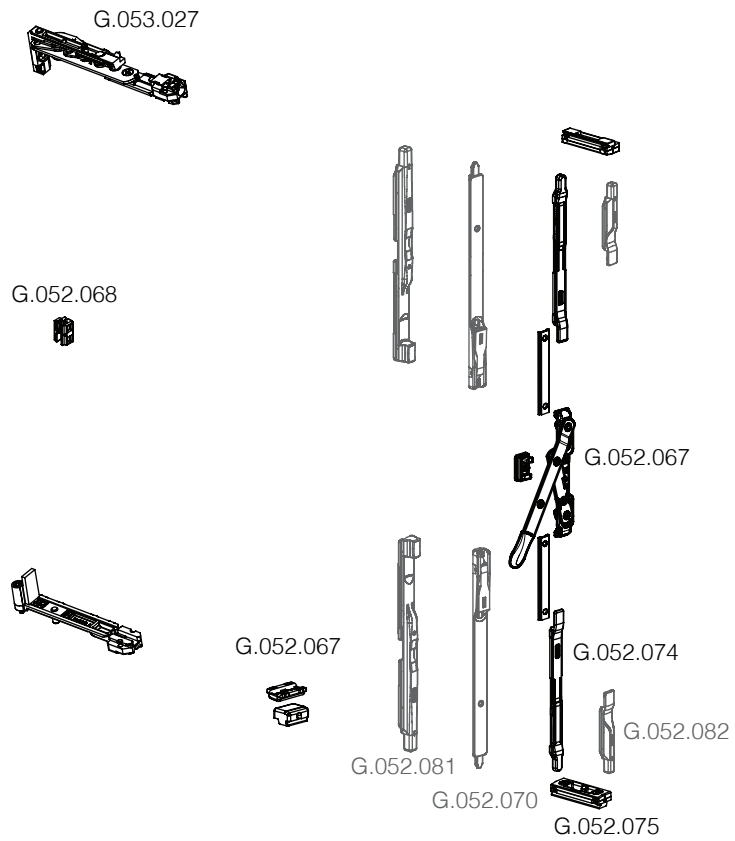

FERRAGEM OCULTA 120 KG OSCILOBATENTE MAIS BATENTE

A.175FE | A.175FO | A.175 | A.165 | A.155 | A.040

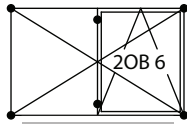
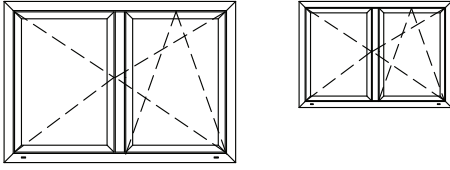

515 < largura < 655
500 < altura < 1400

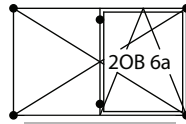

656 < largura < 950
500 < altura < 1400

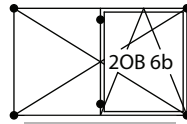

950 < largura < 1300
500 < altura < 1400

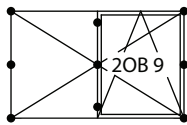

515 < largura < 655
1201 < altura < 2000

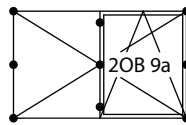

656 < largura < 950
1201 < altura < 2000

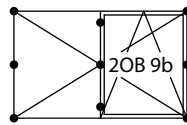

950 < largura < 1300
1201 < altura < 2000

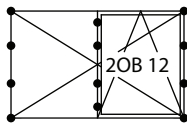

515 < largura < 655
2001 < altura < 2600

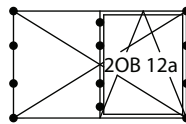

656 < largura < 950
2001 < altura < 2600

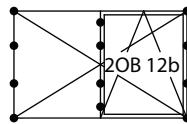

950 < largura < 1300
2001 < altura < 2600

	referência		designação	2OB 6 2OB 6a 2OB 6b 2OB 9 2OB 9a 2OB 9b 2OB 12 2OB 12a 2OB 12b									
	urban	axis		2OB 6	2OB 6a	2OB 6b	2OB 9	2OB 9a	2OB 9b	2OB 12	2OB 12a	2OB 12b	
KIT	G.052.001 G.052.101		Cremona 1G	1	1	1	1	1	1	1	1	1	1
	G.053.020		Kit OB 515 - 655mm esq.	1	-	-	1	-	-	1	-	-	-
	G.053.021		Kit OB 515 - 655mm dir.	1	-	-	1	-	-	1	-	-	-
	G.053.022		Kit OB 655 - 1300mm esq.	-	1	1	-	1	1	-	1	1	1
	G.053.023		Kit OB 655 - 1300mm dir.	-	1	1	-	1	1	-	1	1	1
Complementos	G.052.060		Transmissão cremone 1G	1	1	1	1	1	1	1	1	1	1
	G.052.072		Ponto de fecho folha	-	-	-	1	1	1	2	2	2	2
	G.052.073		Ponto de fecho aro	-	-	-	1	1	1	2	2	2	2
	G.053.024		Ponto fecho ad. vertical	-	-	-	1	1	1	1	1	1	1
	G.053.025		Ponto fecho ad. horizontal	-	-	1	-	-	1	-	-	1	1
	G.053.026		Compasso sup. L>950mm	-	-	1	-	-	1	-	-	1	1
Ferragem 2ª Folha	G.053.027		Dobradiça OC.120 kg esq.	1	1	1	1	1	1	1	1	1	1
	G.053.028		Dobradiça OC.120 kg dir.	1	1	1	1	1	1	1	1	1	1
	G.053.029		Kit fecho Bidirecional	1	1	1	1	1	1	1	1	1	1
	G.052.067		Suporte folha	1	1	1	1	1	1	1	1	1	1
	G.052.068		Limitador de flecha	-	-	-	1	1	1	2	2	2	2

FERRAGEM OCULTA 120 KG OSCILOBATENTE MAIS BATENTE

A.175FE | A.175FO | A.175 | A.165 | A.155 | A.040

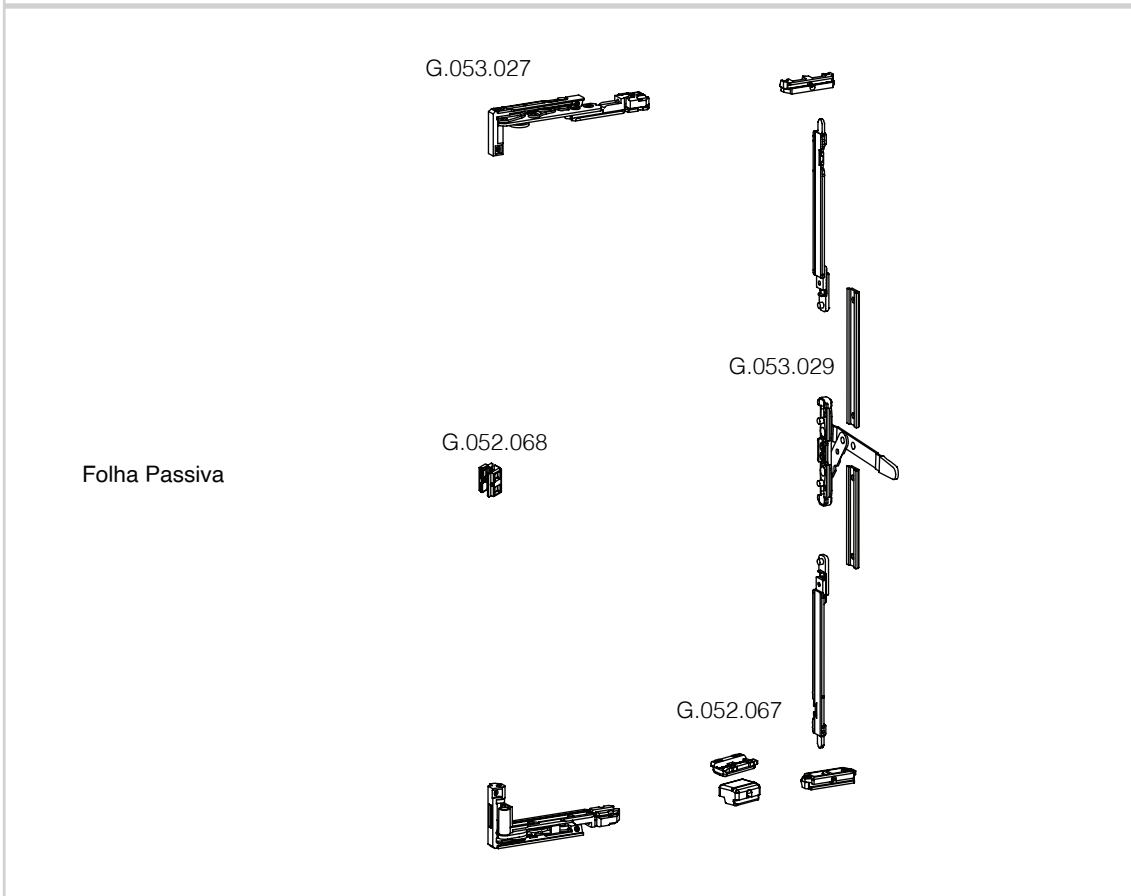
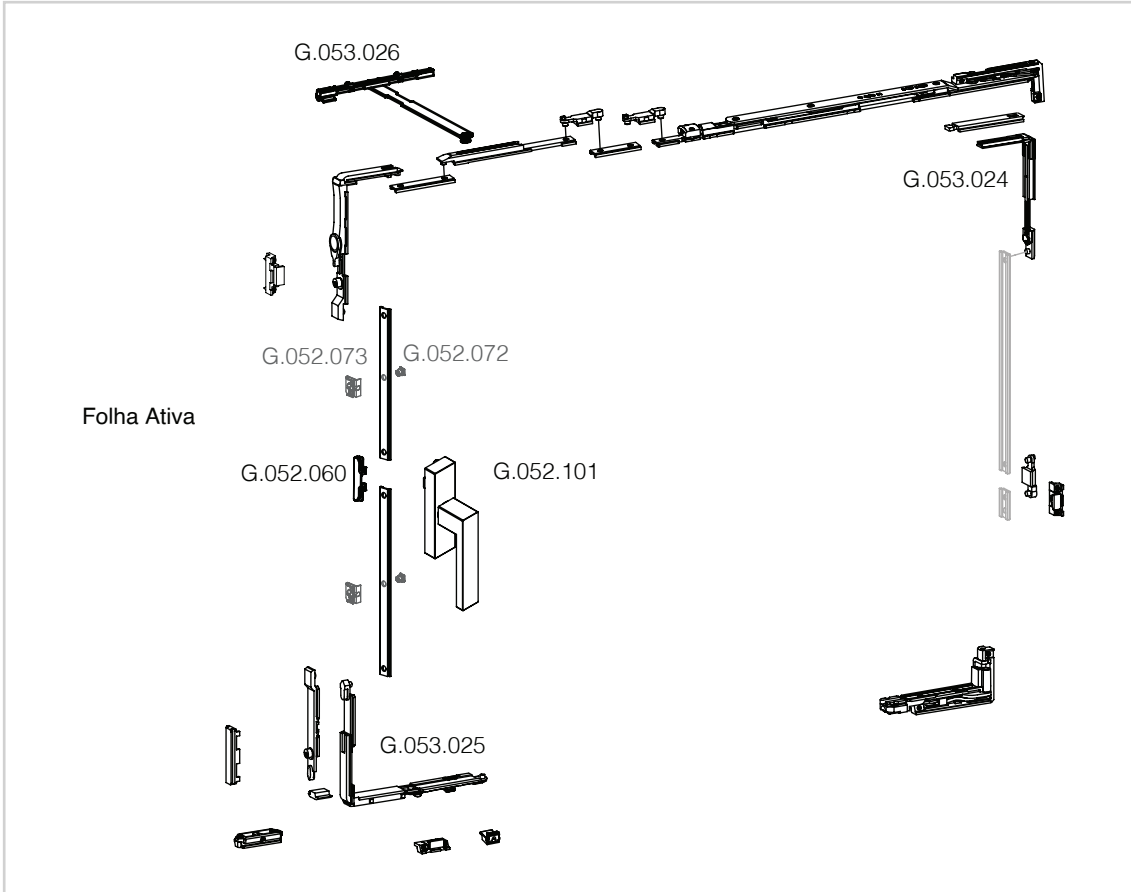

Extrusal[®]

Alumínio com perfil humano.

 **Rua do Sacobão - Aradas**
3810 - 454 Aveiro
Portugal

 **www.extrusal.pt**
tecnico@extrusal.pt
(+351) 234 378 900

